

Article number: 201580M840PL

Description: E+G Screw GN 1580-M8-40-PL-H
Hygienic design

Measures

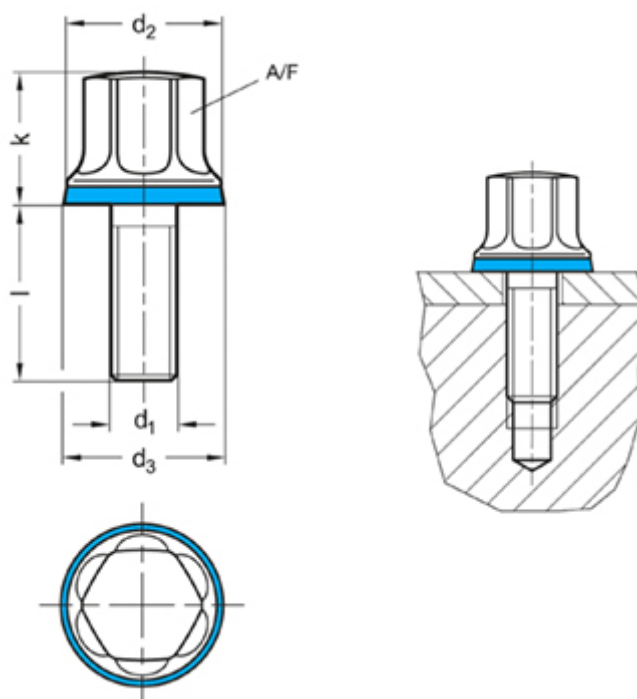

d1	= M 8
d2	= 18
d3	= 18.8
k	= 14.5
L	= 40
t min	= -
Weight in (g)	= 30